

revolution

SCAGNELLATO | FERRARESE



Tavoletta in alluminio, certificata idonea per appalti pubblici e privati

Aluminum writing tablet, with certification suitable for projects and tenders

Paleta en aluminio, certificada para licitaciones públicas y privadas

Snodo in alluminio con meccanismo antipánico per tavoletta, garantisce estrema tenuta

Joint in aluminum with antishock for tablet, allows a high endurance

Soporte para paleta hecho en aluminio con mecanismo anti-pánico, garantizado para uso rudo

Appoggiabraccio ribaltabile

Capsizable armrest pad

Brazo abatible

Bracciolo in alluminio o in plastica

Aluminum or plastic armrest

Brazo en aluminio o en plastico

Sedile in polipropilene

Polypropylene seat

Asiento en polipropileno

Struttura in acciaio 25 x 1,6 mm

Steel frame 25 x 1,6 mm

Estructura en acero 25 x 1,6 mm

Tappo sottopiede in materiale anti graffio

Underfeet plugs in anti scratching material

Regaton en material indeformable.

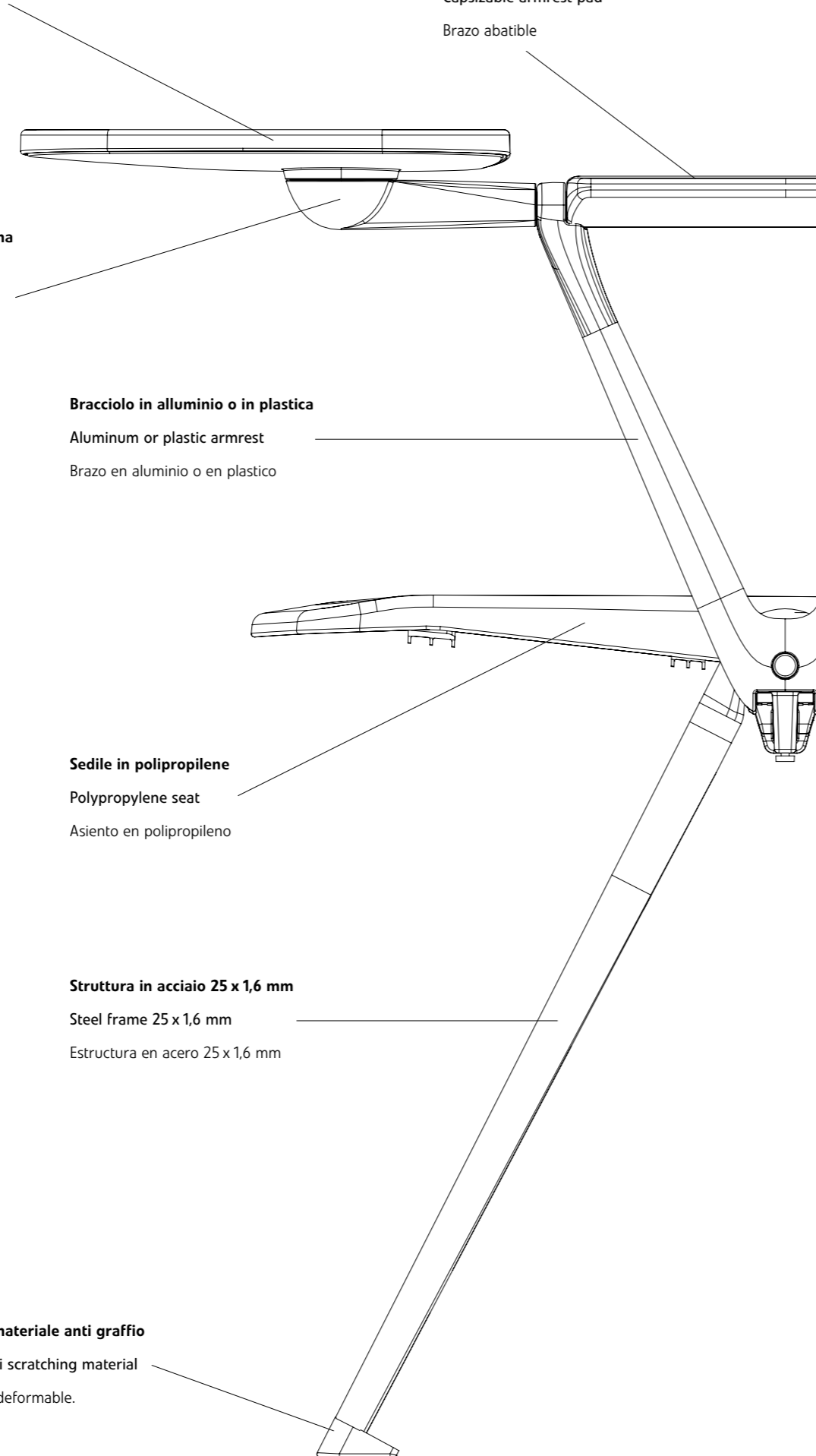

Revolution nasce dall'idea di realizzare un prodotto con il massimo delle prestazioni e con costi contenuti. Il progetto parte dall'analisi di esperienze precedenti, assunte come linee guida per la realizzazione di nuove soluzioni tecniche al fine di creare un prodotto estremamente evoluto. Sono stati dedicati 3 anni di studio ed ingenti investimenti per completare questo progetto, approdato nella realizzazione di una sedia innovativa, dal design semplice, gradevole, che ha superato tutti i test di sicurezza.

La sua versatilità la rende adatta a tutte le esigenze richieste, non solo a quelle rivolte ad una sedia attesa/conferenza, ma anche per altri utilizzi particolari, qualora necessitino di un prodotto funzionale e resistente. Revolution si compone di una vasta gamma di varianti, grazie alla quantità e qualità dei suoi vari componenti.

Cerantola è presente nel mercato dei componenti per sedute da quasi 30 anni, investendo in ricerca di nuove tecnologie e materiali al fine di garantire la massima qualità e affidabilità dei propri prodotti.

Revolution originates from the research of a product able to offer the best performances at a competitive price. The project started from the analysis of previous experiences, using guidelines for adopting new technical solutions in order to create an extremely advanced product. Three years of study and huge investments have been committed to this project, resulting in an innovative chair, with a simple and attractive design, able to complete all safety tests.

Its versatility makes it suitable for many different requirements and needs, addressed not only to a waiting/conference chair, but also to other uses, in seeking a strong and functional solution. Revolution offers a wide range of options, thanks to the quantity and quality of its components. Cerantola has been in the chair components industry for nearly 30 years, with a constant investment in improved technologies and materials, to ensure the highest possible quality and reliability of its products.

Revolution nace de la idea de crear el mejor compromiso entre la calidad y el precio. El proyecto inicia con el análisis de experiencias anteriores, tomadas como líneas a seguir para la aplicación de nuevas soluciones técnicas con el fin de crear un producto muy evolucionado. Después de tres años dedicados a una exhaustiva investigación, un minucioso estudio de diseño y masivas inversiones, se concretizo este proyecto, con la creación de una silla innovadora, con diseño simple y agradable, que ha superado todas las pruebas de seguridad requeridas.

Su versatilidad hace que sea adecuado para todas las necesidades, no necesariamente por un uso referente a comunidad o conferencia, sino también para otros usos especiales, en caso de necesidad de un artículo funcional y duradero. Revolution se compone de una amplia gama de líneas, gracias a la cantidad y calidad de sus diversos componentes.

Cerantola está presente en el mercado de los componentes para muebles desde casi 30 años, invirtiendo en la investigación de nuevas tecnologías y materiales con el fin de garantizar la máxima calidad y fiabilidad de sus productos.

EVOLUTION



Revolution è l'evoluzione della tradizionale sedia attesa/conferenza, della quale considera il principio d'utilizzo. La nuova soluzione prevede l'uso di una varietà allargata di componenti ad alta funzionalità e componibilità, particolarmente curati nella realizzazione, attraverso l'impiego di materiali tradizionali e d'avanguardia, che collaborano al risultato tecnologico ed estetico, adatto a moderni utilizzi.

REVOLUTION

Revolution is one step beyond the standard concept of waiting/conference chair, whose basic use is nevertheless provided. In addition, this new solution is characterised by a wider range of parts and accessories, all extremely functional and interchangeable, conceived and produced with accuracy through the combined use of traditional and advanced materials, contributing to a technological and aesthetic result suitable for modern and multipurpose solutions.

Revolution es la evolución de la silla tradicional de conferencia y espera, y esta fue la idea a la cual fue concebida para su uso primario. La nueva solución implica el uso de una variedad amplia de componentes de alta funcionalidad y modularidad, con especial atención en la implementación a través de la utilización de materiales tradicionales y de vanguardia, que cooperan en un logro tecnológico y estético, adecuado para su uso moderno.

Componenti per sedia base composta da struttura in acciaio, sedile e schienale in polipropilene completa di accessori per l'assemblaggio.

Components for the base version of the chair consist of a steel frame, polypropylene seat and back with all the hardware needed for the assembly.

Componentes para silla estándar, compuesta de estructura de acero, asiento y respaldo en polipropileno con accesorios para el montaje.



Componenti per le varianti più complesse, con braccioli e tavoletta, base girevole su ruote, sedile e schienale in versione da tappezzare.

Components for more articulated varieties of the chair, with armrests and writing tablet, swivel base on castors, seat and back in the version for upholstery.

Componentes para variantes más complejas, con reposabrazos y paleta, base giratoria sobre ruedas, asientos y respaldo en versión para tapizar.

L'intercambiabilità dei componenti permette di passare facilmente e velocemente dalle versioni semplici alle versioni più complesse.

The possibility of interchanging components allows an easy and quick change from simple versions to more complex ones.

La intercambiabilidad de componentes le permite cambiar rápida y fácilmente de las versiones simples a las versiones más complejas.



A seconda degli ambienti e delle esigenze, attraverso la sostituzione di pochi pezzi si realizzano sedie adatte a scopi diversi, dalla sedia conferenza con l'aggancio unione e braccioli alla sedia girevole versione studio.

Depending on the environments and on the needs, through the substitution of few parts, it will be possible to have chairs suitable for different purposes, from the conference chair with linking device and armrests to the office and training swivel chair.

A diferentes entornos y necesidades, mediante la sustitución de algunas piezas las sillas se transforman para diferentes propósitos, desde su uso para un auditorio con apoyabrazos y pieza unión hasta su versión de silla giratoria para oficinas.



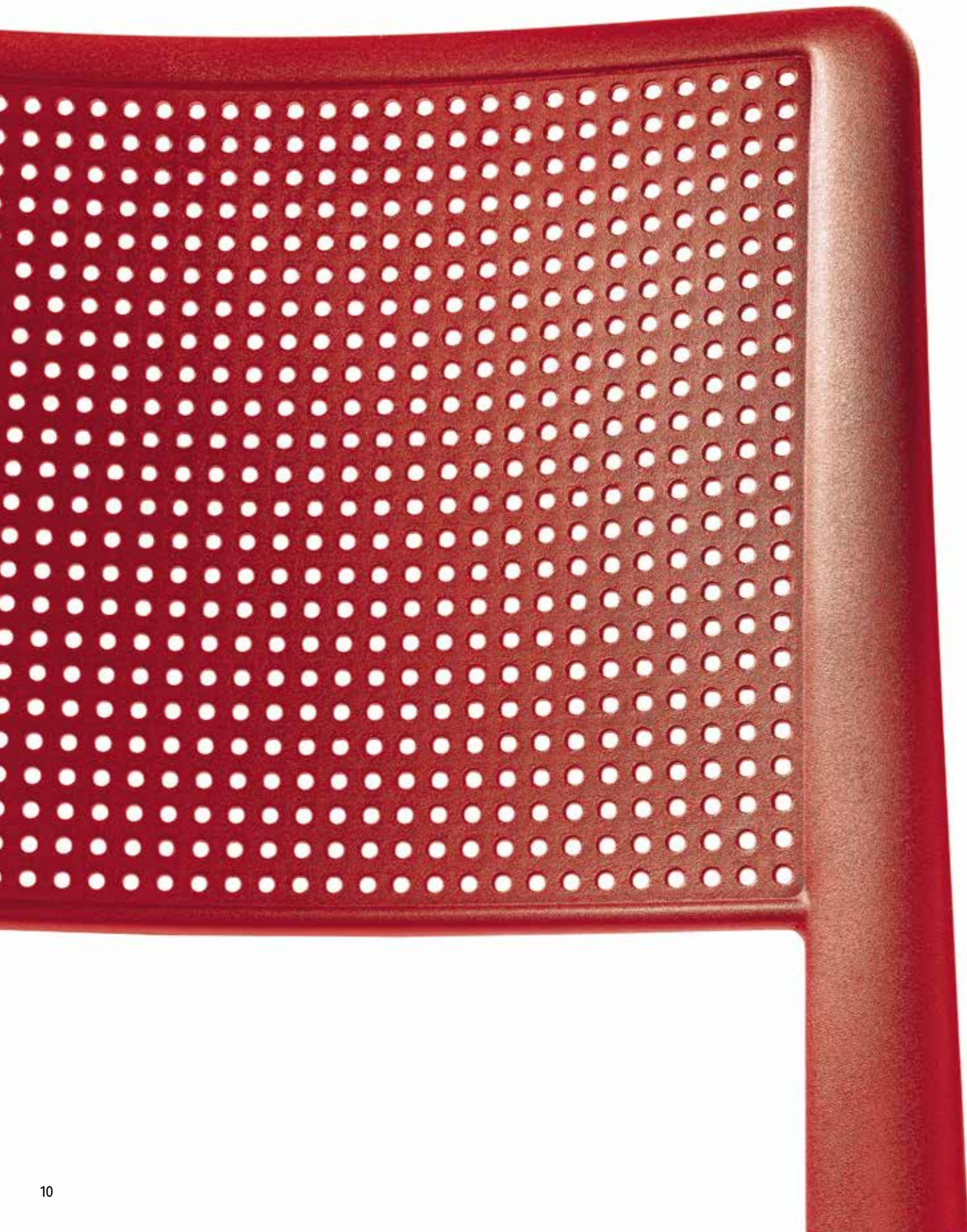



Il particolare tappo laterale, brevettato, svolge molteplici funzioni.

La prima è quella di coprire il foro del tubo della struttura, la seconda è quella di consentire l'unione tra due sedie. Questo accessorio è già fornito nella sedia in versione senza braccioli. La terza funzione è quella di migliorare la stabilità nella fase di impilaggio, facendo da guida; pertanto mediante questo accessorio le sedie si impilano in una colonna verticale, estremamente solida. Il trasporto tramite carrello risulta assolutamente agevole e sicuro. Un'altra funzione è quella di evitare che le scocche entrino in contatto nella situazione di impilaggio, preservandole da questo tipo di usura.

The innovative, patented lateral plug, carries out several different functions.

The first one is to cover and close the hole of the frame's tube, the second one is to allow the union between the chairs. This accessory is incorporated into the chair with the version without armrests.

The third function is to improve the stability of the chairs while stacked, acting as a guide, so that through this accessory the chairs are locked on a very solid vertical column. In this way, the transportation with the trolley is very simple and safe.

Finally, one more important function is to avoid any contact between the shells in the stacking phase, safeguarding the plastics from any type of damage.

El detalle de la tapa lateral, patentado, realiza múltiples funciones.

La primera es para cubrir el agujero del tubo de la estructura, el segundo es permitir la unión entre dos sillas. Este accesorio ya está incluido en la versión base de la silla sin brazos.

La tercera función es la de mejorar la estabilidad en la fase de apilamiento, incluyendo en su diseño una guía oculta; por lo tanto, utilizando este accesorio las sillas se apilan en una columna vertical muy estable. El transporte a través de una carretilla de carga es absolutamente seguro y fácil.

Otra función es evitar que las estructuras metálicas rocen entre sí en una situación de apilamiento, preservando las mismas de un posible desgaste.



Il particolare piedino collabora con il tappo laterale, evitando alle strutture di entrare in contatto nella posizione di impilaggio, proteggendole da eventuali danneggiamenti.

A specific underfeet plug integrates the function of the lateral plug, avoiding contact between the frames when stacked, acting as a protection from possible damage.

La forma del regatón, coopera con la función de la tapa lateral, evitando que las estructuras entren en contacto entre si en la posición de apilamiento, protegiéndolas de los daños.





Quando la sedia è munita di braccioli si utilizza uno speciale dispositivo di aggancio laterale, molto solido e con la funzione telescopica per poter dare anche spazio alla tavoletta scrittoio, quando prevista.

For chairs equipped with armrests, a special device has been conceived as a side link, which is very solid and has a telescopic function in order to allow for the easy location of the writing tablet, when included.

Cuando la silla está equipada con brazos, se utiliza un dispositivo de acoplamiento especial, muy sólido y con movimiento telescópico para poder también dar espacio a la paleta de escritura, si se prevé su instalación.



La parte superiore del bracciolo possiede la peculiarità di ruotare sul proprio asse. Nella posizione verticale permette l'impilaggio della sedia pur avendo i braccioli, anche con tavoletta. Le posizioni orizzontali ci permettono di modificare la distanza fra i due braccioli di 8 cm, favorendone l'adattabilità alle diverse corporature, aumentando il confort della seduta.

The upper part of the armrest has the special feature of rotating on its own axis. On the vertical position it allows the stacking of the chair with armrests, even with the writing tablet. The horizontal positions allows for up to 8 cm modification of the distance between the armrests, ensuring the adaptability to all different body sizes, therefore improving the chairs comfort.

La parte superior del apoyabrazos tiene la particularidad de girar sobre su eje. En la posición vertical permite el apilamiento de la silla con sus brazos, también posible en la versión brazo con paleta. En sus posiciones horizontales (abatiéndolo a la derecha o a la izquierda) nos permiten cambiar la distancia entre los dos brazos de 8 cm, lo que favorece la adaptación de diferentes tamaño y estaturas y aumentando la comodidad del asiento para lo más corpulentos.



Lo snodo e la base della tavoletta scrittoio, brevettati, sono in alluminio, mentre la superficie di lavoro è rivestita in ABS. Il movimento della tavoletta è certificato antipánico e la stessa si disarma semplicemente con il movimento della gamba dell'utilizzatore, quando questi passa dalla posizione seduta a quella eretta, riportandola automaticamente in posizione di riposo. La solidità della struttura in alluminio ha permesso al sistema di superare i test di resistenza ed ottenere le varie certificazioni di legge.

The joint and base of the writing tablet, patented, are in aluminium, while the surface is covered in ABS. The tablet movement is certified with antishock and it can be taken down very easily by the user with a leg movement, while standing up from a sitting position, bringing the table back automatically to the resting position. The solidity of the aluminium structure allows the system to pass the resistance tests and to achieve the specific certifications in compliance with the existing norms.

La base y el soporte de la paleta, patentadas, son de aluminio, mientras que la superficie de trabajo está recubierta de ABS. El movimiento de la tableta tiene certificado anti-pánico y regresa automáticamente a su posición original simplemente con el movimiento de la pierna del usuario, cuando éste pasa de una posición sentada a una posición de pie. La resistencia de la estructura de aluminio ha permitido que este sistema supere las pruebas necesarias para obtener la mayoría de las certificaciones presentes en el mercado.



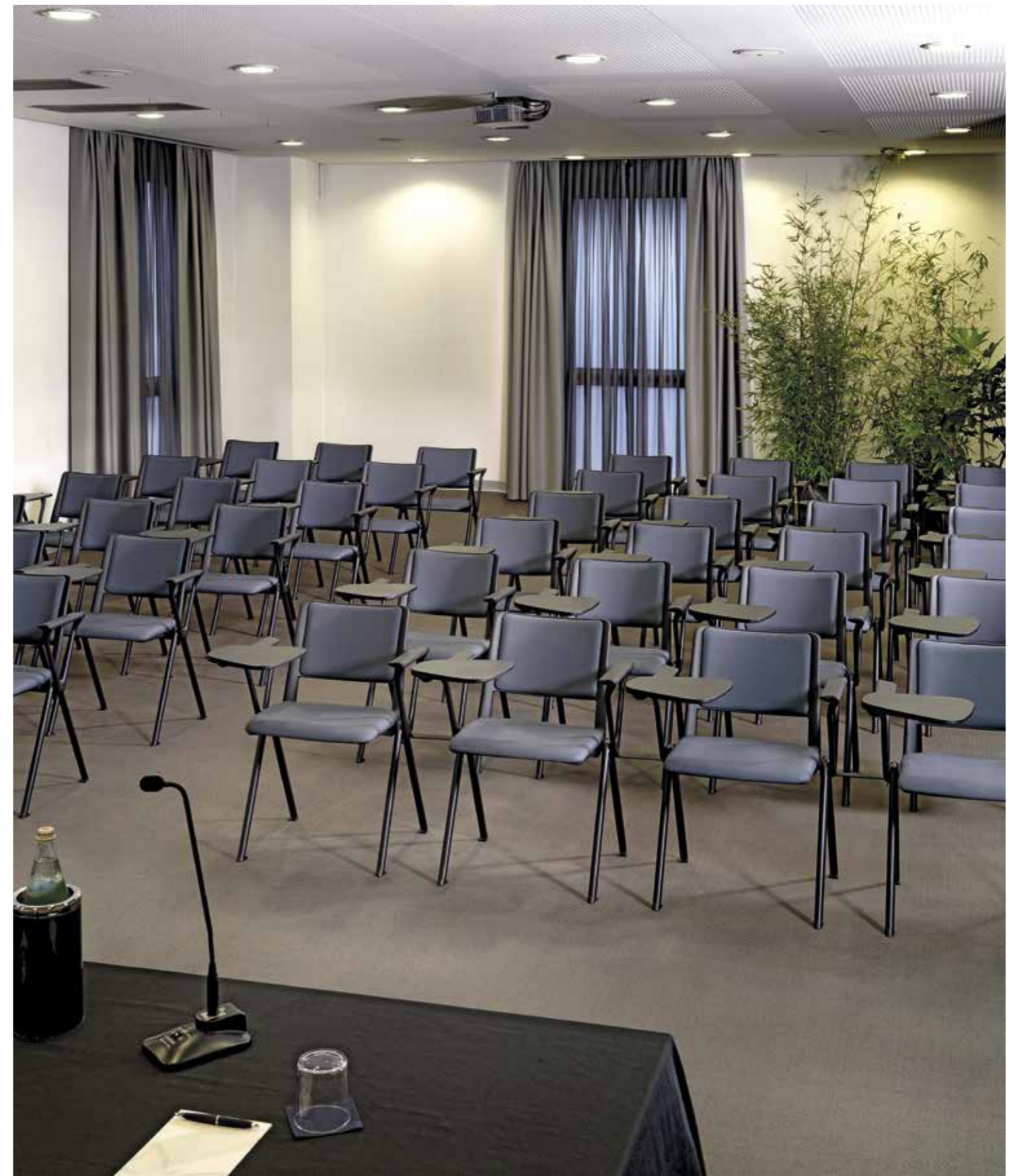







La seduta può essere montata su trave al fine di creare moduli da 2 a 5 posti. Le panche possono essere composte con diversi tipi di gamba. In particolare si sottolinea la gamba con piede per fissaggio a pavimento, requisito fondamentale per molte sale conferenza o sale attese in locali pubblici come aeroporti e stazioni ferroviarie.

The chair can be placed on a beam in order to create units from 2 to 5 seats. Different kinds of legs are available for benches. Amongst all, it is worth mentioning the bench with a leg that can be fixed to the floor, a great feature for many conference rooms or public waiting areas, as seen and used in many airports and railway stations.

Los asientos pueden ser instalados en una viga de diferente largo con el fin de crear módulos de bancada desde 2 hasta 5 plazas. Las bancadas se pueden hacer con diferentes tipos de pata. En particular, se hace hincapié en el modelo de pata para anclaje en piso, un requisito fundamental para muchas salas de conferencias o salas de espera en los lugares públicos, como aeropuertos y estaciones de tren.





IMBALLI PACKAGING EMBALAJE

L'attento studio dell'imballo di Revolution permette di ottimizzare i volumi in tutte le situazioni di trasporto. Il particolare sistema di impilaggio riduce le dimensioni della scatola rispetto a quelle delle normali sedie conferenza in commercio.

The careful study which is behind the Revolution packaging allows to optimise the volumes in all the different freight options. The particular stacking system reduces the sizes of boxes compared to the ones of the standard conference chairs which are in the market.

El estudio cuidadoso de los embalajes de Revolución permite optimizar los volúmenes en todas las situaciones de transporte. El sistema de apilamiento particular, reduce el tamaño de la caja, en comparación con el embalaje de sillas de conferencia que existen en el mercado.

4 pezzi per scatola | 4 pieces per box | 4 unidades por caja

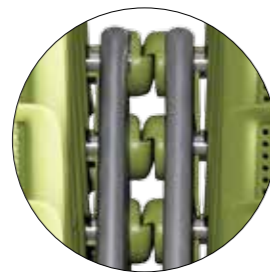

Le sedie montate possono essere trasportate anche su pallet. Su ogni pallet possono essere sistemate 72 sedie senza braccioli, le colonne vengono poste sul pallet, agganciandole una con l'altra tramite il tappo laterale ed assicurandole ulteriormente con reggie di nylon.

The chairs, once assembled, can be carried also on pallets. In each pallet it is possible to place up to 72 chairs without armrests, the columns are set on the pallet, hooked one to the other through the lateral plug and in addition protected with nylon strings.

Las sillas pueden ser transportadas en tarimas también ya completamente ensambladas. En cada tarima se pueden acomodar 72 sillas sin brazos. Las pilas se posicionan sobre la tarima, uniéndolas unas a otras por medio del enganche del tapón lateral, y asegurando el todo con fleje de nylon.

In caso di spedizione della sedia smontata in componenti, lo speciale imballo riduce notevolmente il volume dei pallets delle strutture e di conseguenza ne ottimizza le quantità di stoccaggio. In un container da 40 piedi HC si possono stoccare circa 2.200 sedie complete senza braccioli, risultato mai raggiunto fino ad ora da nessuna sedia analoga.

In case of freight of a knock down chair in components, the special packaging allows to reduce significantly the number of pallets used for the frames and as a consequence it optimises the stock quantity. In a 40 cbm HC container it will be possible to fit up to a maximum of 2.200 complete chairs without armrests, a sensational result which has never been achieved by standard conference chairs.

En caso de envío de la silla desmontada en componentes, el embalaje especial reduce en gran medida el volumen de las tarimas de las estructuras, y en consecuencia optimiza la cantidad de almacenamiento. En un contenedor de 40 pies High Cube se puede almacenar hasta 2.200 sillas completas sin brazos, un resultado nunca alcanzado hasta ahora por cualquier silla similar.

260 pezzi per bancale | 260 pieces per pallet | 260 piezas por palet



COLORI PLASTICHE PLASTICS COLORS COLORES DE PLÁSTICO

Colori disponibili:
Available colours:
Colores disponibles:



Blu (RAL 5003)
Blue (RAL 5003)
Blu (RAL 5003)



Sabbia (RAL 1019)
Sand (RAL 1019)
Sand (RAL 1019)



Nero (RAL 9005)
Black (RAL 9005)
Negro (RAL 9005)



Arancione (RAL 2003)
Orange (RAL 2003)
Naranja (RAL 2003)

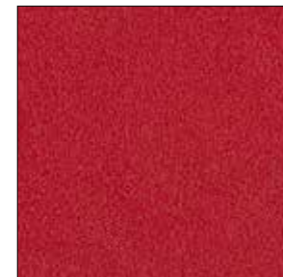

Rosso (RAL 3000)
Red (RAL 3000)
Rojo (RAL 3000)



Verde (PANTONE 7495EC)
Green (PANTONE 7495EC)
Verde (PANTONE 7495EC)

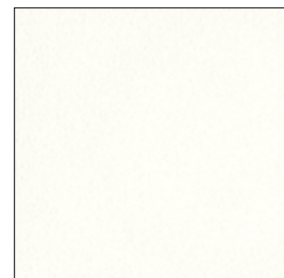

Bianco (RAL 9003)
White (RAL 9003)
Blanco (RAL 9003)



Grigio (RAL 7012)
Grey (RAL 7012)
Gris (RAL 7012)

I colori campione presenti in queste pagine possono essere validi come riferimento indicativo. Per avere un riscontro preciso consigliamo di consultare i campioni colore reali.
The colours are only to be considered as an indication of the real colour. To get a precise feedback should consult the real colour samples.
Los colores de la muestra en estas páginas pueden ser valiosos como guía de referencia. Para obtener una respuesta precisa deben consultar a las muestras reales de color.

FINITURE STRUTTURE STRUCTURES FINISHES ESTRUCTURAS ACABADOS

Finiture disponibili:
Available finishes:
Acabados disponibles:

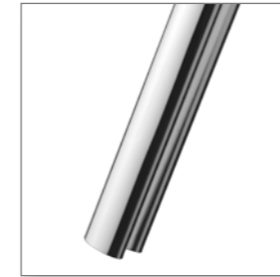

Cromo
Chrome
Cromado

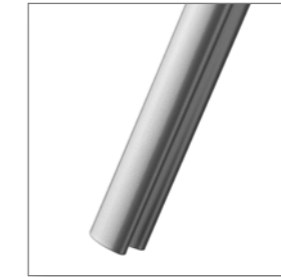

Verniciato Grigio
Grey varnished
Gris pintado



Verniciato Nero
Black varnished
Negro pintado

DATI TECNICI TECHNICAL DATA DATOS TÉCNICOS

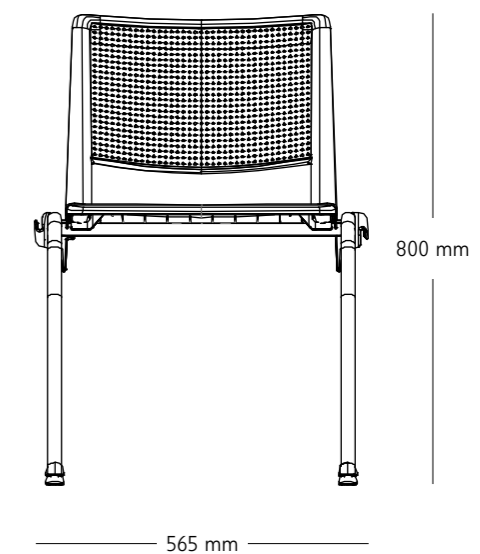
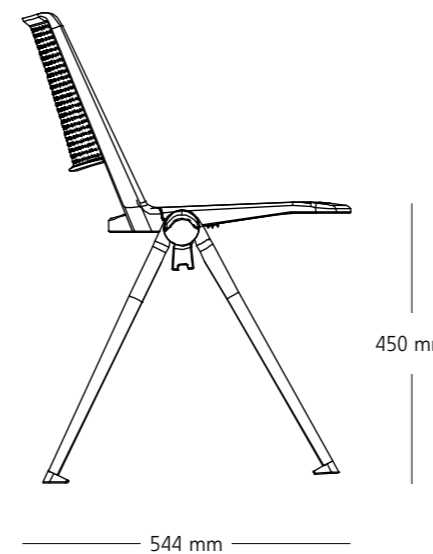

RICONOSCIMENTI AWARDS PREMIOS



CERTIFICAZIONI CERTIFICATION CERTIFICACIÓN

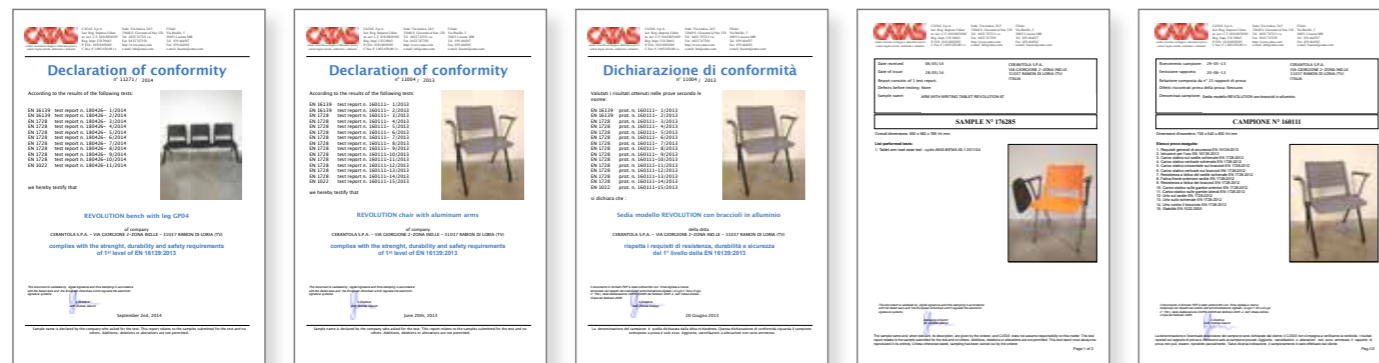

BREVETTI PATENTS PATENTES

REVOLUTION ha 5 brevetti per Europa, USA, CANADA ed altri stati.
 REVOLUTION has 5 patents for EUROPE, USA, CANADA and other countries.
 REVOLUTION tienes 5 patentes para EUROPA, STADOS UNIDOS, CANADA y otros países.

revolution

componenti kit - kit components - componentes kit

SEDILI E SCHIENALI | SEATS AND BACKS | ASIENTOS Y RESPALDOS

	<p>REVOLUTION/01 interno schienale in plastica inner plastic back interno respaldo en plastico</p>
	<p>REVOLUTION/02N esterno schienale in plastica nero black outer plastic back externo respaldo en plastico negro</p>
	<p>REVOLUTION/02W esterno schienale in plastica bianco white outer plastic back externo respaldo en plastico blanco</p>
	<p>REVOLUTION/03 interno sedile in plastica inner plastic seat interno asiento en plastico</p>
	<p>REVOLUTION/04N esterno sedile in plastica nero black outer plastic seat externo asiento en plastico negro</p>
	<p>REVOLUTION/04W esterno sedile in plastica bianco white outer plastic seat externo asiento en plastico blanco</p>
	<p>REVOLUTION/24 schienale in plastica plastic back respaldo en plastico</p> <p> /24B /24G /24N /24O /24R /24S /24V /24W </p>
	<p>REVOLUTION/25 sedile in plastica plastic seat asiento en plastico</p> <p> /25B /25G /25N /25O /25R /25S /25V /25W </p>
	<p>REVOLUTION/34N esterno sedile in plastica nero black outer plastic seat externo asiento en plastico negro</p>
	<p>REVOLUTION/34W esterno sedile in plastica bianco white outer plastic seat externo asiento en plastico blanco</p>
	<p>REVOLUTION 50 schienale in rete mesh back respaldo en malla</p>
	<p>REVOLUTION 52 esterno schienale per rete outer back for mesh externo respaldo para malla</p>
	<p>REVOLUTION 51 interno schienale per rete inner back for mesh interno respaldo para malla</p>



REVOLUTION/05
fusto 4 gambe verniciato nero | black 4 legs frame | estructura 4 patas negra

REVOLUTION/06
fusto 4 gambe cromato | chrome 4 legs frame | estructura 4 patas cromada

REVOLUTION/07
fusto 4 gambe verniciato grigio | grey 4 legs frame | estructura 4 patas gris



REVOLUTION/10
fusto panca - girevole | frame for bench - swivel chair | estructura para bancada - silla giratoria



P18
piastra gas alluminio | aluminum gas plate | plato gas en aluminio

BRACCIOLI | ARMRESTS | BRAZOS



REVOLUTION /20-21
coppia braccioli in plastica nera | couple black plastic armrests | juego brazos en plastico negro



REVOLUTION /62
bracciolo sx in alluminio verniciato nero | left aluminum black arm | brazo izquierdo en aluminio barnizado negro



REVOLUTION /63
bracciolo dx in alluminio verniciato nero | right aluminum black arm | brazo derecho en aluminio



REVOLUTION/64
bracciolo sx in alluminio lucido pad nero | left arm polished aluminum black pad | brazo izquierdo en aluminio lucido pad negro

REVOLUTION/64W
bracciolo sx in alluminio lucido pad bianco | left arm polished aluminum white pad | brazo izquierdo en aluminio lucido pad bianco



REVOLUTION/65
bracciolo dx in alluminio lucido pad nero | right arm polished aluminum black pad | brazo derecho en aluminio lucido pad negro

REVOLUTION/65W
bracciolo dx in alluminio lucido pad bianco | right arm polished aluminum white pad | brazo derecho en aluminio lucido pad bianco



REVOLUTION/66
bracciolo sx in alluminio verniciato nero con tavoletta | left arm black aluminum with tablet | brazo izquierdo en alluminio negro con pala



REVOLUTION/67
bracciolo dx in alluminio verniciato nero con tavoletta | right arm black aluminum with tablet | brazo derecho en alluminio negro con pala



REVOLUTION/68
bracciolo sx in alluminio lucido con tavoletta | left arm polished aluminum with tablet | brazo izquierdo en aluminio lucido con pala



REVOLUTION/69
bracciolo dx in alluminio lucido con tavoletta | right arm polished aluminum with tablet | brazo derecho en alluminio lucido con pala

ACCESSORI SEDIA | CHAIR ACCESSORIES | ACCESORIOS SILLA



REVOLUTION/81
aggancio unione in metallo | metal linking device | enganche union en metal

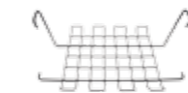

cestino portariviste | basket for student chair | cesto estante para revistas

ATTACCHI, VITI E TAPPI | SUPPORTS, SCREWS AND PLUGS | SOPORTES, TORNILLOS Y TAPONES



REVOLUTION/18
set tappi laterali in plastica per panca/girevole | set lateral plugs for bench/swivel chair | juego tapanes laterales para bancada/silla giratoria

/18B /18G /18N /18O /18R /18S /18V /18W



REVOLUTION/31
set tappi laterali in plastica per 4 gambe | set lateral plugs for 4 legs chair | juego tapanes laterales para estructura 4 patas

/31B /31G /31N /31O /31R /31S /31V /31W



REVOLUTION/32
tubo in ferro per sedie | iron tube for chair | tubo en hierro para sillas



REVOLUTION/43
set tappi sottopiede | set underfeet plugs | juego tapanes para patas



REVOLUTION/61
set adattatore per schienale | set adaptor for back | juego adaptador espara respaldo



VT20
vite 6x23 autofilettante | self tapping screws 6x23 | tornillo autoroscante 6x23

COMPONENTI GIREVOLE | COMPONENTS FOR SWIVEL CHAIR | COMPONENTES SILLA GIRATORIA

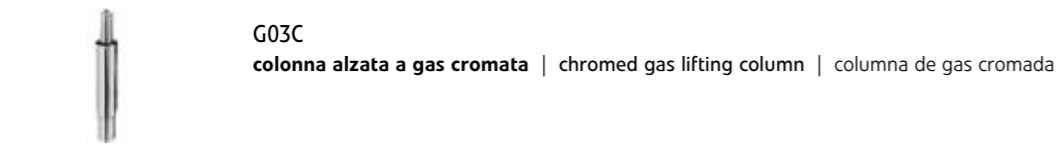

G03C
colonna alzata a gas cromata | chromed gas lifting column | columna de gas cromada

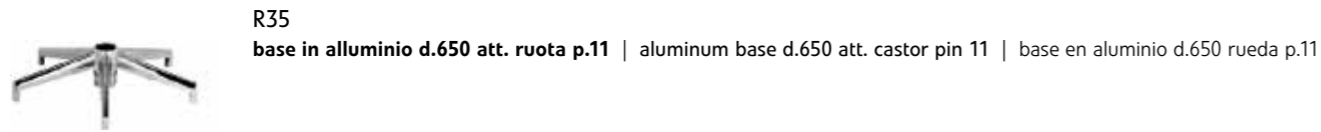

R35
base in alluminio d.650 att. ruota p.11 | aluminum base d.650 att. castor pin 11 | base en aluminio d.650 rueda p.11



RT09
ruota ø 50 perno 11 nera | black castor ø 50 pin 11 | rueda ø 50 p. 11 negra

COMPONENTI PANCA | BENCH COMPONENTS | COMPONENTES BANCADA

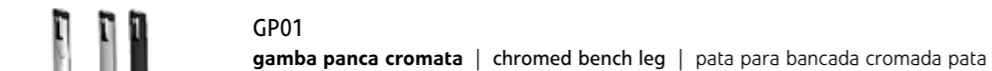

GP01
gamba panca cromata | chromed bench leg | pata para bancada cromada pata



GP01A
gamba panca verniciata grigia | grey bench leg | pata para bancada gris



GP01N
gamba panca verniciata nera | black bench leg | pata para bancada negro

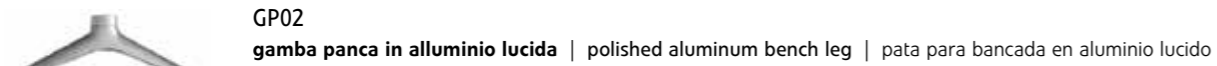

GP02
gamba panca in alluminio lucida | polished aluminum bench leg | pata para bancada en alluminio lucido



GP02A
gamba panca in alluminio verniciata grigia | aluminum bench leg grey varnished | pata para bancada en alluminio gris

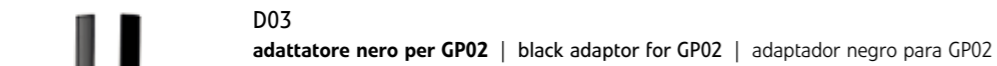

D03
adattatore nero per GP02 | black adaptor for GP02 | adattador negro para GP02



D03A
adattatore grigio per GP02A | grey adaptor for GP02 | adattador gris para GP02



GP03N
gamba panca in alluminio fissa verniciata nera | fixed aluminum bench leg black varnished | pata para bancada en alluminio negra



GP04
gamba in nylon per panca | nylon legs for bench | pata en nylon para bancada



D04
adattatore per GP03N | adaptor for GP03N | adattador para GP03N

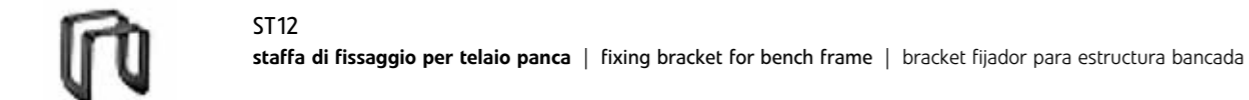

ST12
staffa di fissaggio per telaio panca | fixing bracket for bench frame | bracket fijador para estructura bancada



TRA01
trave tubo rettangolare 80x30x1020 2 posti | beam rectangular tube 80x30x1020 2 seats | viga rectangular para bancada 80x30x1020 2 asientos

TRA02
trave tubo rettangolare 80x30x1600 3 posti | beam rectangular tube 80x30x1600 3 seats | viga rectangular para bancada 80x30x1600 3 asientos

TRA03
trave tubo rettangolare 80x30x2040 4 posti | beam rectangular tube 80x30x2040 4 seats | viga rectangular para bancada 80x30x2040 4 asientos

TRA04
trave tubo rettangolare 80x30x2550 5 posti | beam rectangular tube 80x30x2550 5 seats | viga rectangular para bancada 80x30x2550 5 asientos



VT18
vite M8x16 per st12 | screw M8x16 for st12 | tornillo M8x16 para st12

BRACCIOLI PANCA E GIREVOLE | ARMRESTS FOR BENCH AND SWIVEL | BRAZOS PARA BANCADA Y GIRATORIA



REVOLUTION/70
bracciolo sx in alluminio verniciato nero | aluminum left arm black varnished | brazo izquierdo en aluminio barnizado negro



REVOLUTION/71
bracciolo dx in alluminio verniciato nero | aluminum right arm black varnished | brazo derecho en aluminio barnizado negro



REVOLUTION/72
bracciolo sx in alluminio lucido pad nero | left arm polished aluminum black pad | brazo izquierdo en alluminio lucido pad negro



REVOLUTION/72W
bracciolo sx in alluminio lucido pad bianco | left arm polished aluminum white pad | brazo izquierdo en alluminio lucido pad bianco



REVOLUTION/73
bracciolo dx in alluminio lucido pad nero | right arm polished aluminum black pad | brazo derecho en alluminio lucido pad negro



REVOLUTION/73W
bracciolo dx in alluminio lucido pad bianco | right arm polished aluminum white pad | brazo derecho en alluminio lucido pad bianco

ACCESSORI PANCA | BENCH ACCESSORIES | ACCESORIOS BANCADA



ST14
staffa di fissaggio per tavolino panca | fixing bracket for bench table | bracket fijador mesa para bancada



TA01
tavolo per panca | table for bench | mesa para bancada



VT13
vite M6x14 per st14 | screw M6x14 for st14 | tornillo M6x14 para st14



JEREMIAH FERRARESE

Nasce a Padova nel 1980 e si laurea in Architettura all'istituto IUAV di Venezia nel 2006. Nel 2005 inizia ad occuparsi di industrial design con particolare interesse al settore dell'arredo.

Born in Padua in 1980 and graduated in Architecture at IUAV Institute of Venice in 2006. In 2005 he began to work as an industrial designer with particular interest in the furniture industry.

Spanish text Spanish text Spanish text Spanish text Spanish text Spanish text Spanish text



PAOLO SCAGNELLATO

Nasce a Padova nel 1952 e si laurea in Architettura a Venezia nel 1976 con relatore l'Arch. Aldo Rossi. Dal 1977 esercita la libera professione.

Born in 1952 in Padua, in 1976 he obtains the degree in Architecture in Venice, with Arch. Aldo Rossi as reference-man. In 1977 he begins his individually.

Spanish text Spanish text Spanish text Spanish text Spanish text Spanish text Spanish text

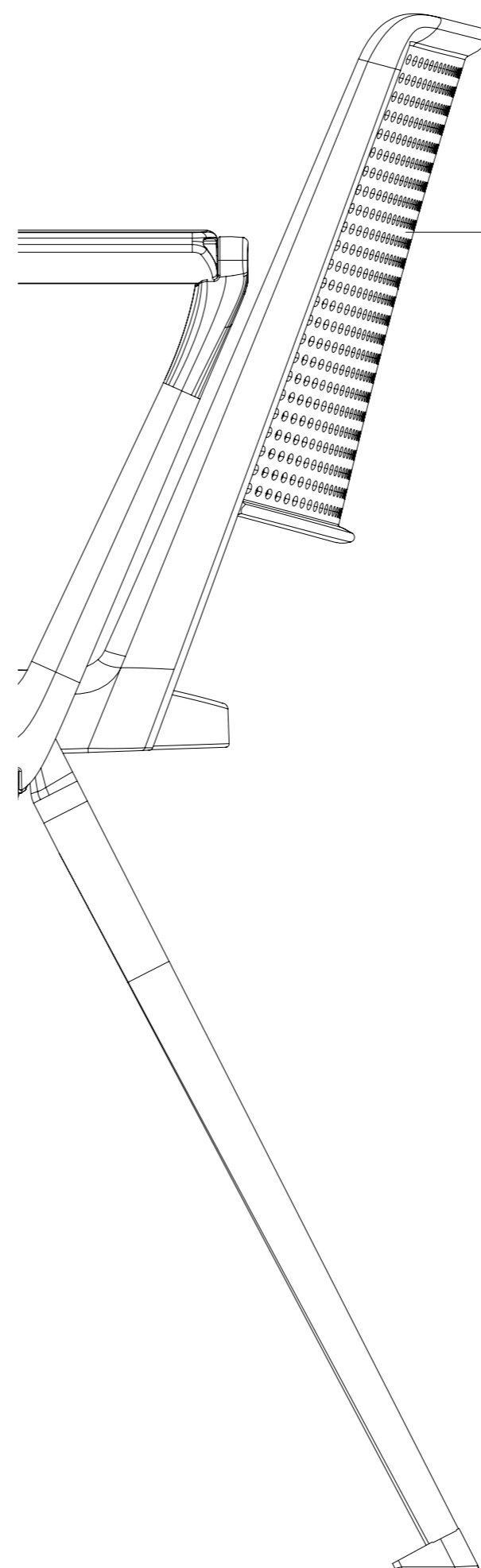

Schienale in polipropilene

Backrest in polypropylene

Respaldo en polipropileno

Cerantola si riserva il diritto di cambiare o migliorare tecnicamente design e specifiche del catalogo in qualsiasi momento e a sua discrezione senza obbligo di preavviso al cliente.

Cerantola reserves the right to change or technically improve the design and specifications of the catalogue at any time and at its discretion without notice to the customer.

Cerantola se reserva el derecho de cambiar y mejorar técnicamente su diseño y especificas técnicas del catálogo en cual sea momento y a su propia discreción sin dar previo aviso a los clientes.



31037 RAMON DI LORIA (TV) Italy
Via Giorgione, 2 - z.i.
Tel. + 39 0423 755 013 r.a.
Fax + 39 0423 755 152

www.cerantola.com
info@cerantola.com